

ICOM

INSTRUCTION MANUAL

COMMUNICATIONS RECEIVER

IC-R1

Icom Inc.

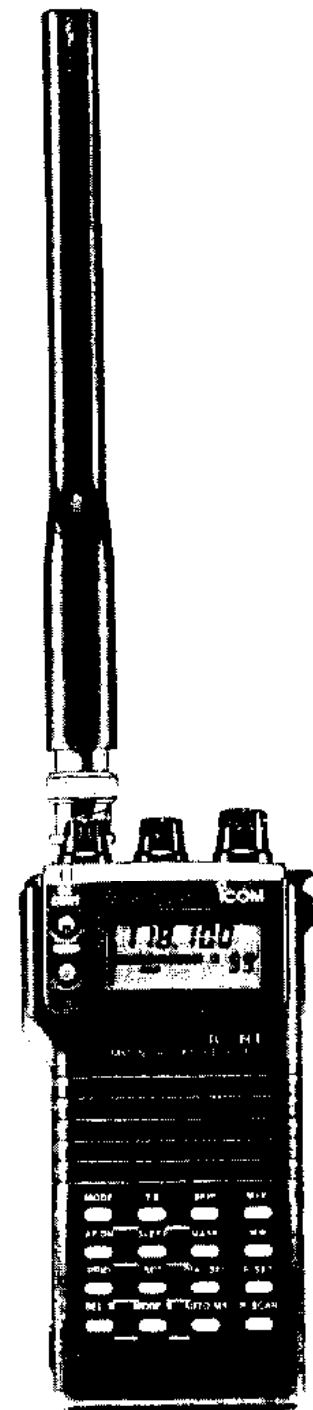

FOREWORD

Thank you for purchasing the **IC-R1 COMMUNICATIONS RECEIVER**. Icom's advanced wideband handheld receiver, the **IC-R1** has the following features:

- Wideband frequency coverage 0.1~1300 MHz* continuously with FM, AM and Wide FM modes.
*Guaranteed range: 2~905 MHz. Some versions are restricted with some frequency ranges.
- Unbelievably compact size including NiCd battery already.
- Dual frequency control system with keyboard and tuning control.
- Multiple scan functions including auto write memory scan.
- 24-hour clock system with timer functions.

IMPORTANT

READ ALL INSTRUCTIONS carefully and completely before using the **IC-R1**.

SAVE THIS INSTRUCTION MANUAL — This instruction manual contains important safety and operating instructions for the **IC-R1**.

FIRST APPLYING POWER

When you purchase the **IC-R1**, the internal NiCd battery and memory backup battery may be empty. Therefore, following procedures are necessary before operation:

- ① Battery charging
- ② CPU resetting

BATTERY CHARGING

Connect the supplied wall charger to an AC outlet and the **[DC 13.8 V]** jack on the receiver top panel.

- Charging time approximately 15 hours.
- When turning ON the receiver, batteries are not charged.

CPU RESETTING

While pushing the **[F]** and **[CL]** keys, turn power ON.

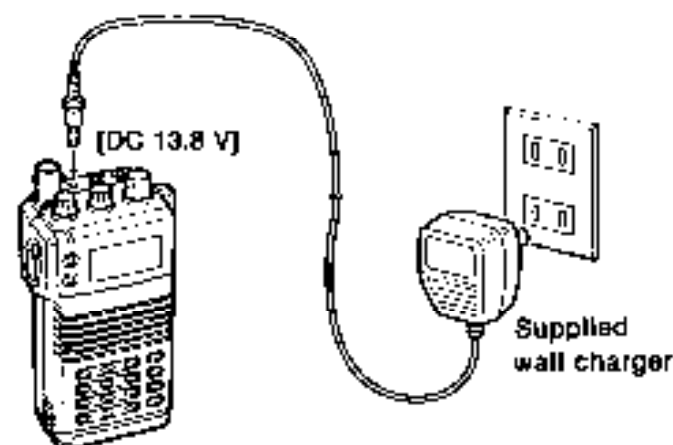

TABLE OF CONTENTS

FOREWORD	i	4 SCAN OPERATION	15
IMPORTANT	i	4-1 Scanning	15
FIRST APPLYING POWER	i	4-2 Programmed scan.....	17
TABLE OF CONTENTS	ii	4-3 Programmed skip scan.....	18
OPERATING NOTES	1	4-4 Memory scan	19
CAUTIONS	1	4-5 Select memory scan	19
UNPACKING	1	4-6 Mode select scan	20
 		4-7 Auto-memory write scan.....	20
1 PRE-OPERATION	2	4-8 Priority watch.....	21
1-1 Attaching accessories	2	5 SET MODE	22
1-2 Power requirement.....	3	5-1 SET mode description.....	22
2 PANEL DESCRIPTION	5	5-2 Setting displays.....	23
2-1 Switches and controls	5	6 CLOCK MODE	25
2-2 Keyboard	7	7 OTHER FUNCTIONS	27
2-3 Function display	8	7-1 Frequency lock	27
3 BASIC OPERATION	9	7-2 Display contrast	27
3-1 Applying power and tuning.....	9	7-3 Low battery indication	27
3-2 Operating modes.....	11	7-4 Power saver.....	27
3-3 Tuning.....	11	7-5 Beep tones	27
3-4 Tuning steps.....	12	7-6 Resetting	28
3-5 Receive modes.....	12	7-7 Recharging lithium batteries	28
3-6 Memory operation.....	13	8 TROUBLESHOOTING	29
		9 SPECIFICATIONS	30
		10 OPTIONS	31

OPERATING NOTES

Information overhead but not intended for you cannot lawfully be used in any way.

The IC-R1 may receive its own oscillated frequency, resulting in no reception or only noise reception on some frequencies.

The IC-R1 may receive interference when receiving excessively strong signals on different frequencies or using an external high-gain antenna.

CAUTIONS

NEVER connect a non-recommended charger. This may result in fire hazard or electric shock.

NEVER connect more than 16 V DC power source to the receiver. This will ruin the receiver.

NEVER allow children to touch the receiver.

DO NOT use or place the receiver in areas with temperatures below -10°C ($+14^{\circ}\text{F}$) or over $+60^{\circ}\text{C}$ ($+140^{\circ}\text{F}$).

UNPACKING

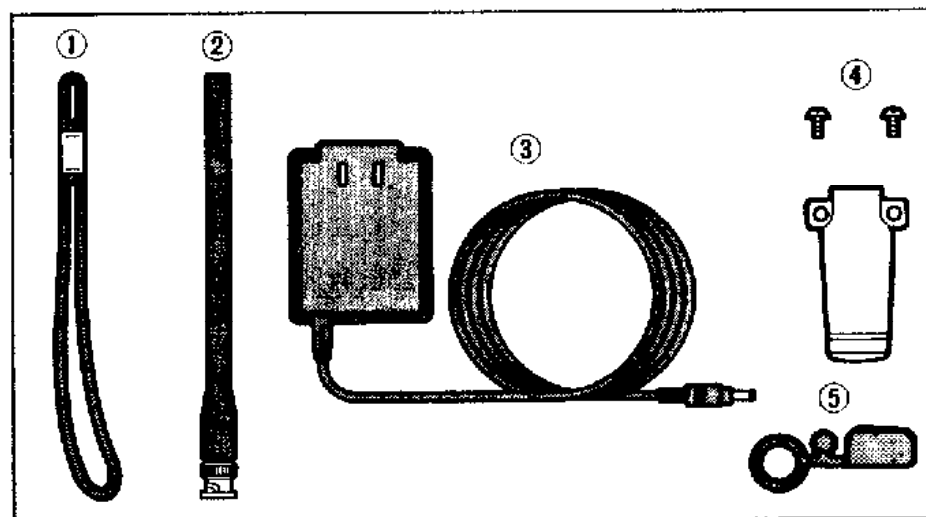

Accessories included with the IC-R1:

	Qty.
① Handstrap	1
② Antenna (FA-4B)	1
③ Wall charger	1
④ Belt clip and screws	1 set
⑤ Rainproof cap	1

1-1 Attaching accessories

ANTENNA AND JACK CAP

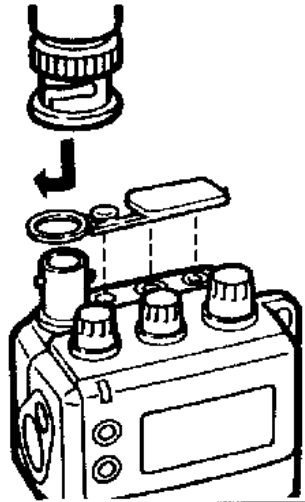

Insert the supplied jack cap and antenna as shown in the diagram.

The jack cap prevents bad contact caused by dust. **DO NOT** forget to insert the cap after battery charging is finished.

HANDSTRAP ATTACHMENT

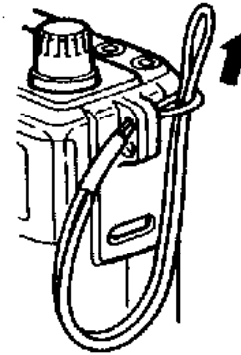

The handstrap allows you to easily carry the receiver. Attach the handstrap as shown in the diagram.

BELT CLIP

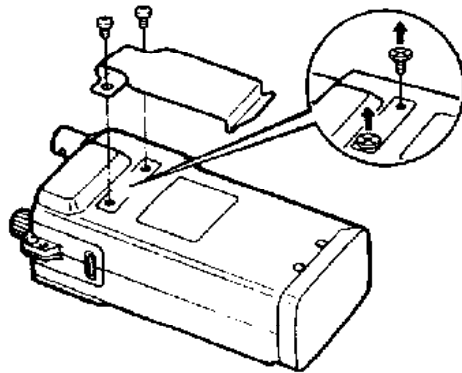

The belt clip allows you to attach the receiver to your belt.

Remove the plastic screws when attaching the belt clip.

BOTTOM CAP REMOVAL

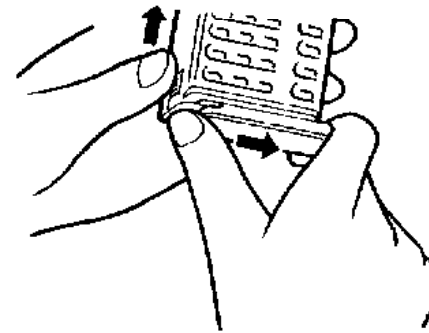

Push the bottom cap release button upwards, then slide the bottom cap to the right with the receiver facing you.

1 PRE-OPERATION

1-2 Power requirement

• Power source

Use any of the following power sources when operating your IC-R1:

- Internal battery (7.2V NiCd)
- 6~16 V DC external power source through the [DC 13.8 V] jack.
- Either optional battery packs BP-81~BP-85 or six AA (R6) size batteries with an optional BP-90 BATTERY CASE.

When attaching a battery pack or connecting an external power source, the internal battery is disconnected from the circuitry.

When the battery pack is discharged, remove it and use the internal battery.

• Charging operation

Connect one charger as described at right.

NEVER connect two or more chargers in the same time.

When the receiver is turned ON, the charging times take longer than described time.

USING BATTERY WISELY

The battery pack is designed to withstand recharging periods longer than 1 week or more and can be fully discharged. However, overcharging or complete discharging shorten the life of a battery. The battery pack can be recharged about 300 times but its battery life can be lengthened to about 500 times as follows:

1. Avoid overcharging. Charging times should be less than 48 hours.
2. Use battery capacity almost completely under normal condition. Charge a battery after the [B] indicator appears.

• Charging connection

INTERNAL BATTERY REGULAR CHARGING

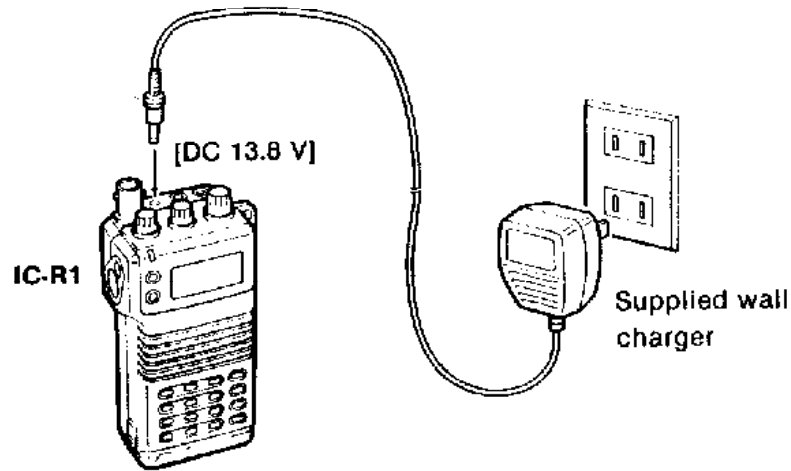

Charging time: 15 hrs. (approx.)

RAPID CHARGING

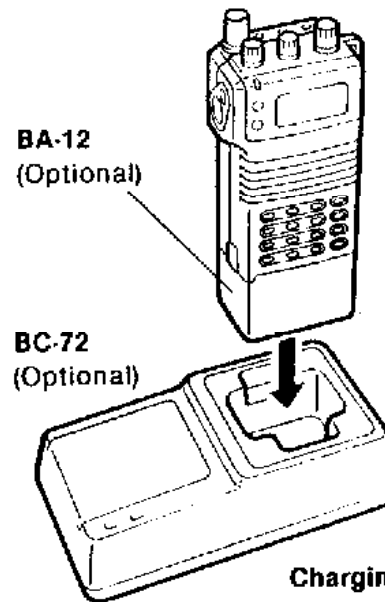

Charging time: 1 hr. (approx.)

BA-12 is necessary to charge the internal battery pack.

An optional battery pack can also be charged.

NiCd batteries with the BP-90 BATTERY CASE cannot be charged using the BC-72.

When an optional battery pack is attached, the internal battery will not be charged.

OPTIONAL BATTERY AND OPTIONAL CHARGER

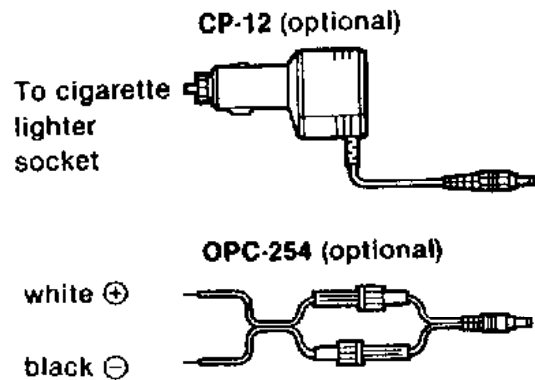

BC-73E/D for BP-81 or 82 only
BC-74A/E/D/V for BP-81~85, 90

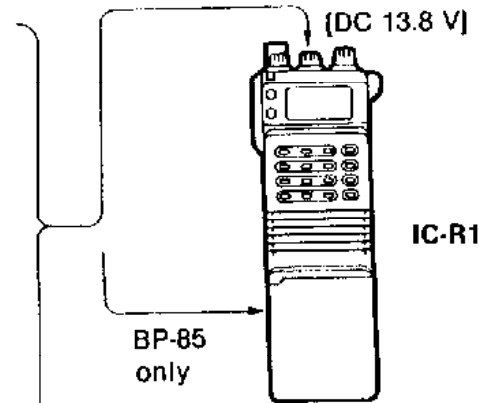

2-1 Switches and controls

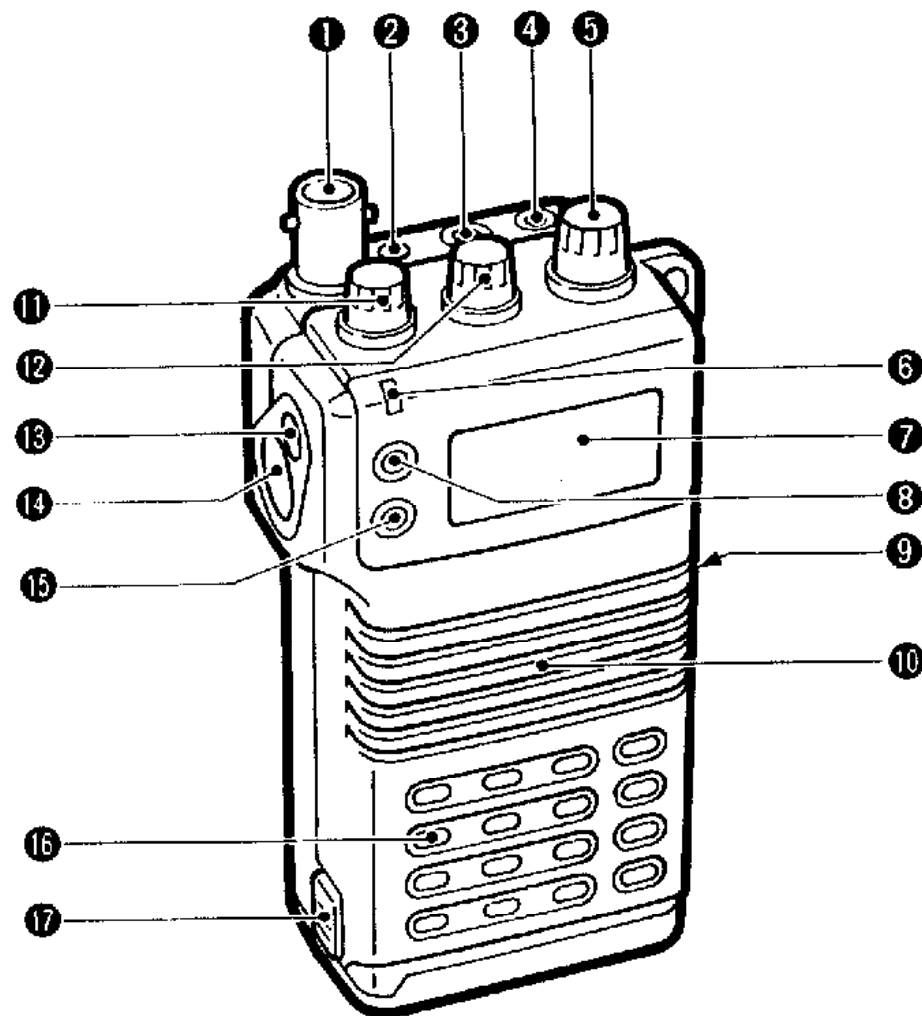
**1 ANTENNA CONNECTOR**

- Connects the supplied flexible antenna. (See p. 2.)
- To connect an external antenna, see p. 1 OPERATING NOTES.

2 EXTERNAL DC POWER JACK [DC 13.8 V]

- Connects the supplied wall charger for charging the internal batteries or attached battery pack.
- Allows operation with a 13.8 V DC power source using an optional cable. (See p. 3.)

3 EXTERNAL SPEAKER JACK [SP]

- Connect an 8 Ω optional speaker or headset, if desired.
- The internal speaker will not function when either option is connected.

4 LINE OUT JACK [LINE OUT]

- Use a submini plug to connect to a tape recorder in order to record the signal being received. Use the volume control to adjust the recording volume.

5 TUNING CONTROL

- Used to set an operating frequency (see p. 11) or a memory channel (see p. 14).

⑥ RECEIVE INDICATOR [RX]

Lights in green while receiving. If you turn the squelch control too far in the counterclockwise direction, noise will be generated and this indicator will light to indicate the need to adjust squelch.

⑦ FUNCTION DISPLAY

Indicates the operating condition. (See p. 8.)

⑧ CONTRAST SWITCH [CONT]

Adjusts the contrast of the display characters. Use with the tuning control. (See p. 27.)

⑨ LIGHT SWITCH [LIGHT]

- Lights the display backlight for approx. 5 sec.
- While pushing [F], push this switch to deactivate the tuning control and keyboard. (See p. 27)

⑩ SPEAKER

Built-in speaker.

⑪ SQUELCH CONTROL [SQUELCH]

Varies the squelch threshold point for audio mute, to eliminate noise under no-signal conditions and optimize signal reception. (See p. 9.)

⑫ VOLUME CONTROL [PWR/VOL]

Turns power ON and adjusts the audio level. (See p. 9.)

⑬ WATCH SWITCH [W]

Activates the clock function. (See p. 25.)

⑭ FUNCTION SWITCH [F]

The keyboard and tuning controls each have one function when used separately and another function when used together with this switch. (See p. 7.)

⑮ MONITOR SWITCH [MONI]

Push to improve reception of weak signals under certain conditions.

⑯ KEYBOARD

Numeric and other function keys for tuning and activating functions. See p. 11 for tuning operation, or p. 7 for a description of functions.

⑰ BATTERY PACK RELEASE BUTTON

Opens the latch for bottom cap or optional battery pack removal when pushed upwards. (See p. 2.)

2 PANEL DESCRIPTION

2-2 Keyboard

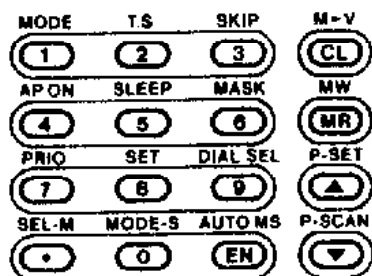

• Function

(0)~(9) (.)

- In VFO mode: inputs the frequency
- In MEMORY mode: inputs the number of the memory channel.

(CL) • Switches from MEMORY mode to VFO mode.

- Stops scanning.
- Clears numeric key input.

(MR) • Changes from VFO mode to MEMORY mode.

- In MEMORY mode, changes the memory channel in units of 10.

(▲) • Increments the memory channel number.

(▼) • Decrements the memory channel number.

(EN) • Enters numerical input.

• Secondary function (while pushing [F])

KEY	NAME	VFO MODE FUNCTION	MEMORY MODE FUNCTION
(F) + (1)	MODE	Selects receive mode.	Not used.
(F) + (2)	T.S	Selects tuning steps.	Not used.
(F) + (3)	SKIP	Not used.	Designates skip channels for memory scan.
(F) + (4)	AP ON	Starts power ON timer (used only in CLOCK mode).	
(F) + (5)	SLEEP	Starts sleep timer.	Starts sleep timer.
(F) + (6)	MASK	Not used.	Turns memory mask function ON/OFF.
(F) + (7)	PRIO	Starts/stops priority scan.	Starts/stops priority scan.
(F) + (8)	SET	Activates SET mode.	Not used.
(F) + (9)	DIAL SEL	Selects steps for DIAL SELECT.	Not used.
(F) + (.)	SEL-M	Not used.	Starts/stops memory select scan.
(F) + (0)	MODE-S	Not used.	Starts/stops mode select scan.
(F) + (EN)	AUTO-MS	Starts/stops auto-memory write scan.	Not used.
(F) + (CL)	M▶V	Not used.	Transfers memory contents to VFO.
(F) + (MR)	MW	Writes to memory channel.	Not used.
(F) + (▲)	P-SET	Activates mode for setting programmed scan frequency range.	Not used.
(F) + (▼)	P-SCAN	Starts/stops programmed scan.	Starts/stops memory scan.

2-3 Function display

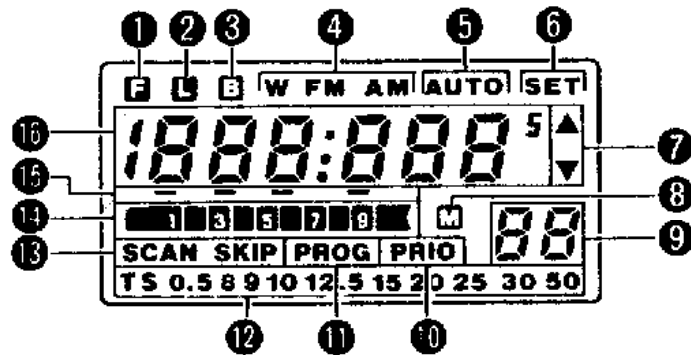

① FUNCTION INDICATOR

Appears when [F] is pushed.

② LOCK INDICATOR

Appears when the frequency lock function is activated. (p. 27)

③ LOW BATTERY INDICATOR

Appears when the connected battery requires charging. (p. 27)

④ RECEIVE MODE INDICATOR

Indicates receive mode. (p. 12)

⑤ AUTO MEMORY WRITE SCAN INDICATOR

Blinks while auto memory write scan activates. (p. 20)

⑥ SET MODE INDICATOR

Appears when SET mode is selected. (p. 22)

⑦ SCAN UP/DOWN INDICATORS

Blinks to indicate direction during scanning. (p. 16)

⑧ MEMORY INDICATOR

Appears when MEMORY mode is selected. (p. 13)

⑨ MEMORY CHANNEL READOUT

Shows the selected memory channel number. (p. 13)

⑩ PRIORITY WATCH INDICATOR

Appears while operating priority watch. (p. 21)

⑪ PROGRAMMED SCAN INDICATOR

Appears when selecting a programmed scan edge channel. (p. 17)

⑫ TUNING STEP INDICATORS

Shows the selected tuning steps. (p. 12)

⑬ SCAN INDICATOR

Appears while scanning. (p. 15)

⑭ S-INDICATOR

Indicates receiving signal strength.

⑮ DIAL SELECT INDICATORS

One indicator appears while pushing [F]. It shows the dial select step. (p. 11)

⑯ FREQUENCY READOUT

Shows the receiving frequency.

3 BASIC OPERATION

3-1 Applying power and tuning

• Before applying power

- (1) Attach the antenna securely.
- (2) Set the top panel controls as shown here.

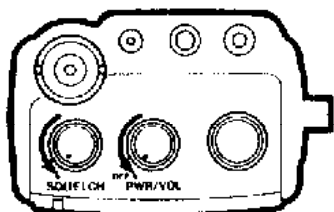

Turn [SQUELCH] and [PWR/VOL] completely counterclockwise.

• Turning power on and adjusting volume

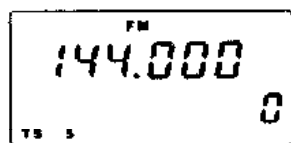
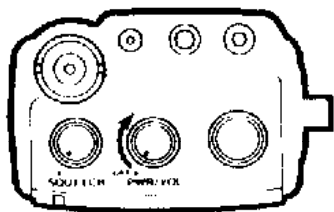

This is the initial display.

- (1) Rotate [PWR/VOL] clockwise to turn ON the power.
 - The function display will turn ON.
- (2) Continue rotating [PWR/VOL] clockwise to adjust the volume.
 - Use the no-signal noise or the received signal to obtain the desired volume level.

• Adjusting squelch

The [SQUELCH] control eliminates noise that is heard when there is no signal being received.

Rotate [SQUELCH] maximum counterclockwise, then rotate the control slowly clockwise until the noise disappears and the [RX] indicator goes off.

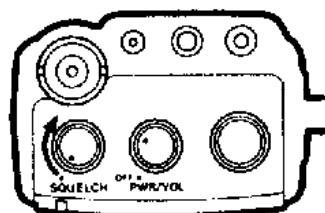

Too far clockwise rotation will not receive weak signals.

• Setting the operating mode

(see p. 12 for detailed instructions)

To receive signals, the receiver must be tuned to the desired frequency. This tuning can only be done in VFO mode.

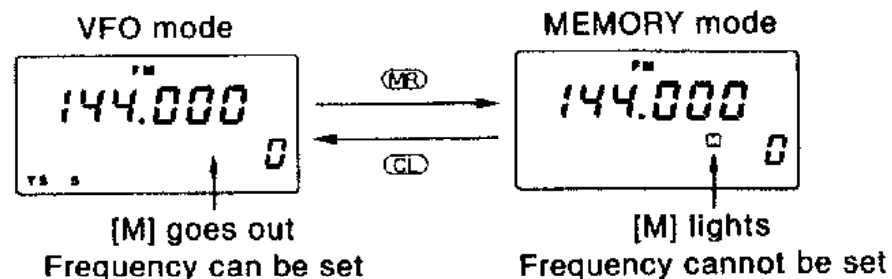

To tune the receiver when it is in MEMORY mode, push [CL] to enter VFO mode.

• Tuning with the keyboard

When you know the frequency you want to listen to, tune it in as follows.

Example: To listen to an FM broadcast at 88.1 MHz

- (1) Select VFO mode. (Push [CL].)
- (2) Use the numeral keys to input the frequency.

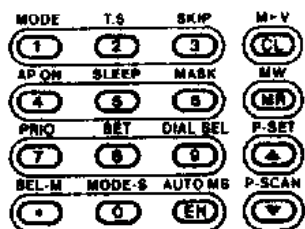

Push [8] [8] [.] [1] [EN].
The frequency will be entered and displayed as shown here.

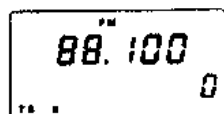

- (3) Select the receive mode. For FM broadcasts, select W FM as follows:

- While pushing [F], push [1] (MODE) until "W FM" appears in the function display.

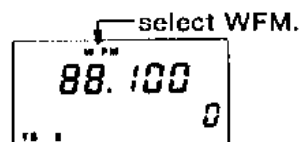

• Tuning with the tuning control

Use the tuning control when the desired frequency is near the frequency that is being displayed or when searching for nearby frequencies.

Example: To listen to amateur band frequencies in the area near 144.500 MHz

- (1) Push [CL] to select VFO mode.
- (2) Set the tuning steps (TS) as follows:

- While pushing [F], push [2] (TS). Keep pushing [F], rotate the tuning control.

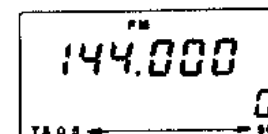

Change with the tuning control

- (3) Select the receive mode:
 - While pushing [F], push [1] (MODE).
- (4) After completing the above steps, use the tuning control to tune.

See p. 11 for additional information on tuning with the tuning control. See p. 12 for additional information on tuning steps.

SIMPLE NUMERIC KEY INPUT

(see p. 11 for additional explanation)

- 144.000 MHz → [1] [4] [4] [EN]
- 0.160 MHz → [0] [.] [1] [6] [EN]
- 7.001 MHz → [7] [.] [0] [0] [1] [EN]
- 1025.000 MHz → [1] [0] [2] [5] [EN]

If you make a mistake when inputting, push [EN] or [CL] and re-input from the beginning.

WHEN YOU DON'T KNOW THE FREQUENCY

Use one of the automatic scan functions when you don't know which frequency you want, or when you want to roam through several broadcasts.

For information on the scan functions, see p. 15.

3 BASIC OPERATION

3-2 Operating modes

Along with its many functions, the IC-R1 is equipped with two basic operating modes which you should understand thoroughly for optimum use.

• VFO mode

- In VFO mode you can set desired frequencies and tuning steps.
- You can also set the content of data to be stored in a memory channel.
- And you can automatically scan frequencies.

• MEMORY mode

- In MEMORY mode you can call up specific memory channels to receive the frequency stored in each channel.
- And you can automatically scan memory channels.

SELECTING VFO OR MEMORY MODE

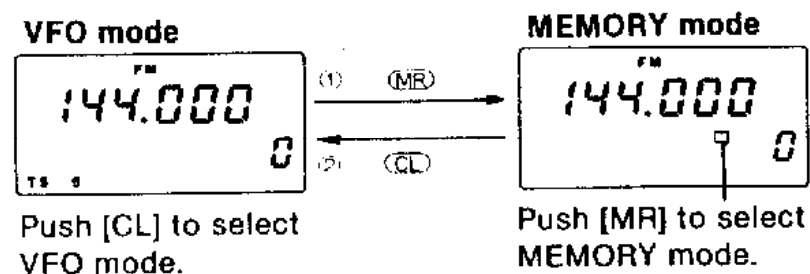

3-3 Tuning

• Using the tuning control

Turn the tuning control to select a frequency. In VFO mode, frequencies change in the tuning steps you have set.

TO CHANGE THE FREQUENCY FASTER:

Use the dial select function to change tuning steps to 100 kHz, 1 MHz, 10 MHz, or 100 MHz.

While pushing [F],
push [9] (DIAL SEL).

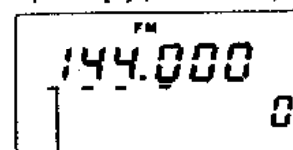

Designates bar display

While pushing [F],
rotate the tuning control.

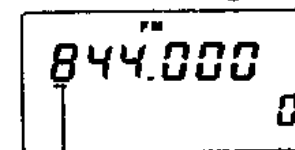

Bar display digit can be changed

• Using the keyboard

- You can select frequencies from 0.1 MHz to 1300 MHz. If you input a frequency outside this range, the frequency will be displayed, but it will change to the most recently used frequency when you push [EN].
- To change 144.000 to 144.580, push [.] [5] [8] [EN].
- To set a frequency containing 0.5 kHz (500 Hz):

Example: 872.124.5

Push [8] [7] [2] [.] [1] [2] [4] [.] [*] [EN]. For the [*] position, you can push any number from [5] to [9]. To delete the 0.5 kHz before pushing [EN], push [.] then any number from [0] to [4].

3-4 Tuning steps

Tuning steps are the smallest steps taken when changing frequencies using the tuning control.

Some tuning steps are determined by frequency band or receive mode, and others are set by tradition. As such, the tuning step must be set to match the desired frequency prior to tuning.

FINE TUNING

All signals have what is called an "occupied bandwidth." They will be received as long as the receiver is tuned to any place within this bandwidth, even though the frequency received may not be the central frequency. In order to tune to the central frequency, the tuning step should be made as small as possible (0.5 or 5 kHz) and the receiver tuned to the point of greatest S indicator deflection.

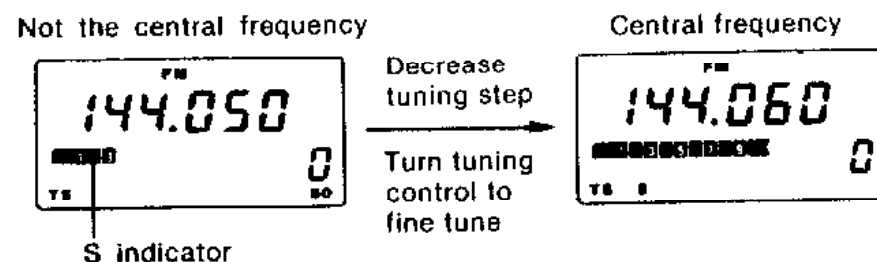

3-5 Receive modes

There are various signal properties and conditions, such as purpose, distance, and frequency band, that determine the receive mode. The IC-R1 receives FM, W FM, and AM modes.

Since the receive mode varies according to the frequency band and the signals being transmitted, you must set the mode before receiving.

MAJOR SYMPTOMS OF INCORRECT RECEIVE MODE

- Distorted sound
- Sudden interruption in receiving
- Noise only
- Noise with weak receiving
- Low or unstable S indicator

When the above occurs, check to make sure you are using the correct mode by pushing and holding [F], then pushing [1] (MODE) to change modes.

3 BASIC OPERATION

3-6 Memory operation

You can store frequencies and receive modes in the memory channels (M-CH) of the IC-R1. This makes it quick and easy to find the frequencies you listen to often, and to scan through several frequencies. The IC-R1 is equipped with 100 memory channels, numbered from 0 to 99. There are a variety of ways to use memory channels when scanning.

MEMORY CHANNEL DESCRIPTIONS

M-CH	Initial setting	Main use and characteristics
0	144.000 MHz FM	• Only this memory channel cannot be masked
1~19	144.000 MHz FM	• Used as normal memory channels.
20~79	Masked*	• Skip designation area for programmed scan (See p. 18.)
80~99	Masked*	• Frequency writing area for auto-memory write scan (See p. 20.)

*Masking makes it easier to select memory channels by "blanking" unwanted memory contents from view.

• Selecting a memory channel

You can select memory channels with the tuning control or the keyboard. See p. 14.

• Writing a memory

- 1) Select the memory channel to be programmed. (See p. 14.)
- 2) Push [CL] to select VFO mode.
- 3) Set the frequency and mode.
- 4) While pushing [F], push and hold [MR] (MW) for 2 seconds.
 - The receiver emits 3 beeps.To check the contents, switch to MEMORY mode.

• Transferring a memory to VFO

- 1) Select the memory channel to be transferred.
- 2) While pushing [F], push and hold [MR] (MW) for 2 seconds.
 - The receiver emits 3 beeps.
 - The receiver returns to VFO mode with carrying the memory contents.





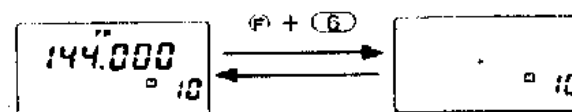



• Masking a memory

- 1) Select the memory channel to be masked.
- 2) While pushing [F], push [6] (MASK) to mask the displayed memory channel.
 - To recall the masked memory channel, repeat step 2.

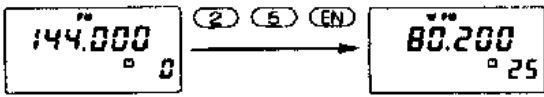

SELECTING A MEMORY CHANNEL

NOTE: Always check to be sure you are in the correct operating mode.

SECTION	MODE	FUNCTION DISPLAY/OPERATION	DESCRIPTION
SELECTING WITH THE TUNING CONTROL 1 Rotate the tuning control. 	MEMORY	Tuning control 	Masked memory channels are not selected. Channels 20 to 99 are masked when the IC-R1 is shipped from the factory or after resetting.
2 While pushing [F], rotate the tuning control. 	MEMORY	[F]+tuning control 	<ul style="list-style-type: none"> All memory channels can be sequentially selected.
SELECTING WITH THE KEYBOARD 3 Push a numeral key+[EN]	MEMORY		<ul style="list-style-type: none"> When 3 or more digits are entered with the numeral keys, only the last 2 digits displayed are valid.
4 Push [▲] or [▼].	MEMORY		Masked memory channels are not selected. <ul style="list-style-type: none"> When either key is pushed and held, the memory channel changes continuously.
CHANGING THE MEMORY CHANNEL NUMBER IN UNITS OF 10 5 Push [MR].	MEMORY		Each time you push the key, the memory channel will change in units of 10.
CHANGING ONLY THE MEMORY CHANNEL NUMBER 6 Push [▲] or [▼].	VFO	Displayed frequency does not change 	<ul style="list-style-type: none"> You can select a memory channel in VFO mode. When either key is pushed and held, the memory channel changes continuously. To display memory contents, switch to MEMORY mode.

4-1 Scanning

Scanning is an automatic search function that detects signals as it checks through frequencies or memory channels.

• Scan types

There are two major scan types: programmed scan which sequentially scans each frequency, and memory scan which sequentially scans each memory channel. See the diagram at right.

AUTOMATIC SCAN RESUME

- Scan automatically resumes 10 seconds after a signal is received.
- However, this function can be disabled in SET mode so that scanning does not automatically resume while receiving a signal. (See p. 23)

SCAN SPEED ADJUSTMENT

The speed at which frequencies and memory channels are searched may be adjusted. The initial setting is twenty per second intervals, but this may be reduced to ten intervals in SET mode. (See p. 23)

TUNING CONTROL FUNCTIONS DURING SCANNING

- You can switch between scanning up or down during a scan by turning the tuning control left or right.
- If you turn the tuning control while stopped on a signal, scanning resumes.

PROGRAMMED SCAN

Scans between 2 programmable frequencies.

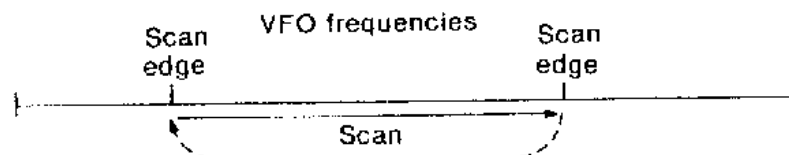

PROGRAMMED SKIP SCAN:

Skips specified frequencies during above scan.

AUTO-MEMORY WRITE SCAN:

Automatically writes the stopped frequencies into memory channels 80~99 during above scan.

MEMORY SCAN

Scans specified range of all memory channels.

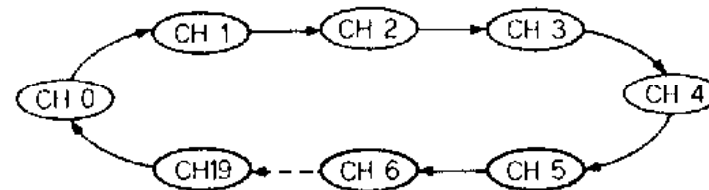

SELECT MEMORY SCAN:

Skips memory channels programmed "SKIP" during above scan.

MODE SELECT SCAN:

Scans only the same mode during above scan.

• Starting and stopping scans

Before scanning, turn [SQUELCH] clockwise until the audio is muted.

SCAN TYPES	START MODE	SCAN START	SCAN STOP	PRE-OPERATION SETTINGS	REF.
Programmed scan	VFO	(F) + P-SCAN	Push [CL], [MR] or the same procedure as SCAN START. If [CL] is used to stop a scan started in MEMORY mode, the IC-R1 enters VFO mode.	Set upper and lower frequency limits (scan edges) for any one of the 10 groups.	P. 17
Programmed skip scan	VFO	(F) + P-SCAN		Set frequencies to SKIP during programmed scanning.	P. 18
Auto-memory write scan	VFO	(F) + AUTOMS EN CAUTION: The programmed contents in memory channels 80~99 are erased.		Set upper and lower frequency limits (scan edges) for any one of the 10 groups.	P. 20
Memory scan	MEMORY	(F) + P-SCAN		Limit the memory channel scan range or all channels (0 to 99) will be scanned.	P. 19
Select memory scan	MEMORY	(F) + SEL-M		Set memory channels to SKIP during scanning.	P. 19
Mode select scan	MEMORY	(F) + MODE-S		Two or more memory channels must be in the same receive mode.	P. 20

4 SCAN OPERATION

4-2 Programmed scan

Programmed scan repeatedly scans in VFO mode between two user-programmed frequencies. Ten frequency band groups can be set for scanning at any frequency ranging from 0.1 and 1300 MHz. The upper and lower frequency band limits from each group are stored in memories A and B.

The initial setting for memory A is 144.000 MHz, FM, 5 kHz step, and that for B is 146.000 MHz, FM, 5kHz step. If these initial settings are not changed, scanning will proceed between 144.000 and 146.000 MHz.

• Setting frequency band groups

- 1) Select VFO mode.
- 2) While pushing [F], push [▲] (P-SET) to select PROGRAM SET mode.
 - One of the following memory displays will appear. (The initial setting is 0A.)

Group number	Memory A	Memory B
0	0A	0b
1	1A	1b
2	2A	2b
...
9	9A	9b

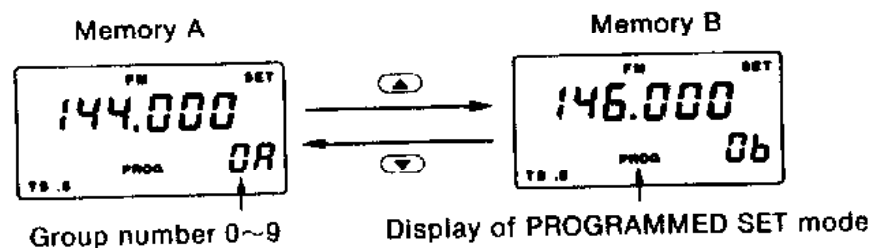

- 3) Push [▲] to increment the memory and group number, and [▼] to decrement.

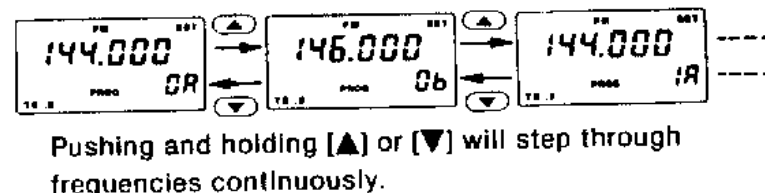

- 4) The upper and lower frequency limits can be set in either memory A or B, but be sure to set memory A and B for the same group.
 - Use the tuning control or keyboard to set frequencies.
- 5) Once the frequencies are set, set the mode and tuning steps for either memory A or B.
- 6) Follow steps 3 to 5 above to set frequencies for all 10 groups (0A, 0B to 9A, 9B).
- 7) After all settings are completed, select the desired group using [▲] or [▼].
 - Programmed scan uses this group.
- 8) Push [CL] to return to VFO mode.

• Starting programmed scan

Before starting programmed scan, scan edge programming is necessary. See instructions on p. 17.

- 1) Select VFO mode.
- 2) While pushing [F], push [▼] (P-SCAN) to start programmed scan.
 - Scan operates within the selected band group.
- 3) When desired, push a digit key to change the band groups.

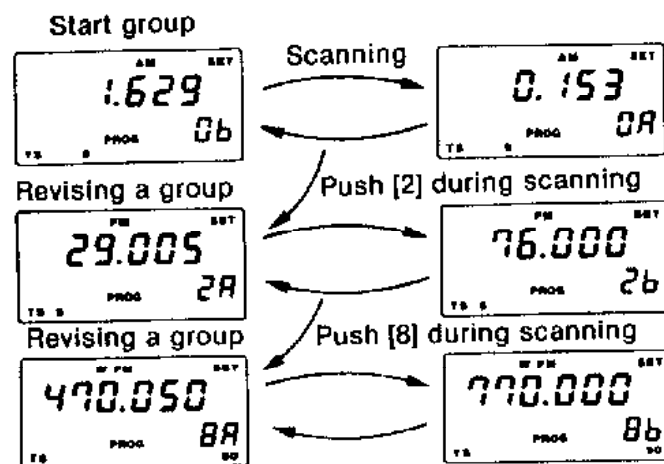

• Stopping programmed scan

Push [CL] or [MR].

4-3 Programmed skip scan

When unwanted frequencies are programmed into memory channels, programmed scan operates as programmed skip scan. Programmed skip scan skips these frequencies during scanning.

Programmed skip scan can be turned OFF in SET mode. See p. 23 for details.

• Programming a skip frequency

- 1) While pushing [F], push [▼] in VFO mode to start programmed scan.
- 2) When scan stops with receiving an unwanted signal, write the frequency as the skip frequency: While pushing [F], push and hold [MR] (MW) for 2 seconds.
 - Frequencies are programmed into masked memory channels in 79~20 in sequence.
 - When all memory channels are programmed, low beep tone are emitted.

• Clearing skip frequencies

TO CLEAR THE SKIP PROGRAMMING:

While pushing [F], push [3] (SKIP) on the desired memory channel.

TO CLEAR THE PROGRAMMED FREQUENCIES:

While pushing [F], push [6] (MASK) on the desired memory channel.

TO CLEAR THE ALL FREQUENCIES:

While pushing [F] and [CL], turn power ON.
(All memories are also cleared.)

4 SCAN OPERATION

4-4 Memory scan

All memory channels in which you have programmed frequencies can be scanned.

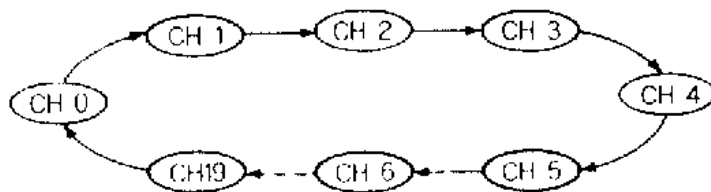

• Starting memory scan.

- 1) Select MEMORY mode.
- 2) While pushing [F], push [▼] (P-SCAN).

• Stopping memory scan.

Push [MR] to clear the scan by MEMORY mode, or push [CL] to clear the scan and return to VFO mode.

Scanning in MEMORY mode normally moves from channel 0 to 99, but the range can be limited in SET mode. (See p. 23.)

4-5 Select memory scan

Unwanted memory channels can be skipped during memory scan for more efficient memory scanning.

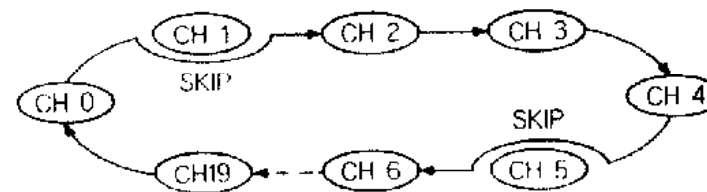

• Selecting and clearing SKIP memory channels

1. Call up the memory channels you want to skip.
2. While pushing [F], push [3] (SKIP).

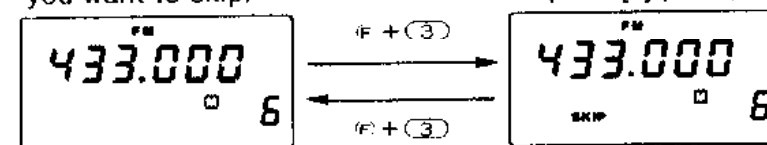

• Starting select memory scan

- 1) Select MEMORY mode.
- 2) While pushing [F], push [•] (SEL-M).

• Stopping select memory scan

Push [MR] to clear the scan by MEMORY mode, or push [CL] to clear the scan and return to VFO mode.

4-6 Mode select scan

This type of memory scan distinguishes modes stored in memory channels, and scans similar receive modes. Two or more channels must be in the same receive mode for mode select scan.

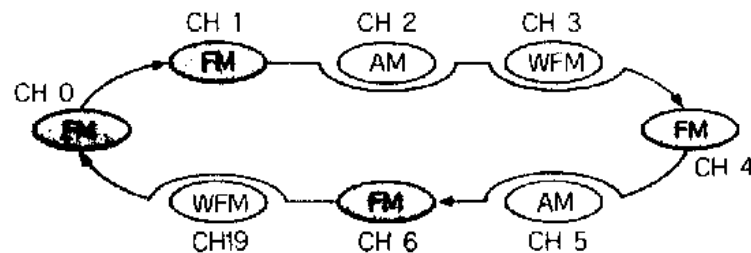

• Starting mode select scan

- 1) Select MEMORY mode.
- 2) Set the receive mode you want to scan, or call up the memory channel where the mode is stored.
- 3) While pushing [F], push [0] (MODE-S).
 - Only memory channels in the same mode will be scanned.

• Stopping mode select scan

Push [MR] to clear the scan by MEMORY mode, or push [CL] to clear the scan and return to VFO mode.

4-7 Auto-memory write scan

Frequencies received as you scan can be stored so you won't have to remember where you found the signal, or so you can listen to the signal later with memory scan or MEMORY mode.

CAUTION: The programmed contents in memory channels 80~99 are erased when starting the scan.

- 1) Select VFO mode.
- 2) While pushing [F], push [EN] (AUTO MS).
 - The scan starts using the selected frequency band group. See "setting frequency band group (p. 17)" for details.
- 3) When receiving a signal, scan pauses.
 - The received frequencies are automatically programmed into memory channels 80~99 in sequence.
 - The scan stops when the frequencies are programmed up to memory channel 99.

• Stopping auto-memory write scan

Push [MR] or [CL] to clear the scan.

4 SCAN OPERATION

4-8 Priority watch

• Priority watch operation

Priority watch monitors a memory channel or memory channels in 5 sec. intervals while listening a VFO frequency.

PRIORITY WATCH TYPES	PRE-OPERATION	START	RESUME CONDITION	STOP
VFO and selected memory channel	<ol style="list-style-type: none"> 1) Set the VFO frequency. 2) Select the memory channel. 	While pushing [F], push [7] (PRIO).	<p>Priority watch pauses when receiving a signal on the memory channel.</p> <p>The watch resumes according to the SET mode condition. (p. 23)</p>	<p>While receiving a VFO frequency:</p> <ul style="list-style-type: none"> • [CL] clears by VFO mode. • [F]+[7] clears by VFO mode. • [MR] clears by MEMORY mode. <p>While receiving a memory channel:</p> <ul style="list-style-type: none"> • [CL] resumes the priority watch.
VFO and memory scan	<ol style="list-style-type: none"> 1) Select MEMORY mode. 2) Start memory scan. 	While pushing [F], push [7] (PRIO) during memory scan.		

• VFO and selected memory channel scan

While using a VFO frequency, priority scan checks the selected memory channel in 5-second intervals. Start priority scan from either MEMORY or VFO mode.

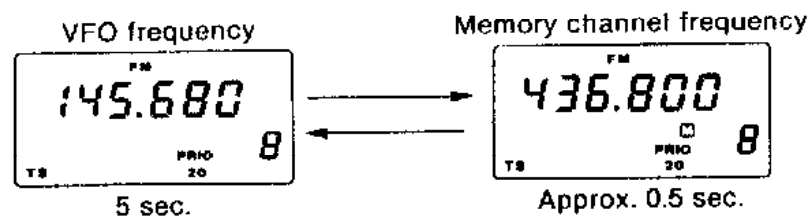

When the selected memory channel is masked, a beep tone will sound indicating that priority scan will not start.

• VFO and memory scan

While using a VFO frequency, priority scan briefly checks each memory channel in numerical order.

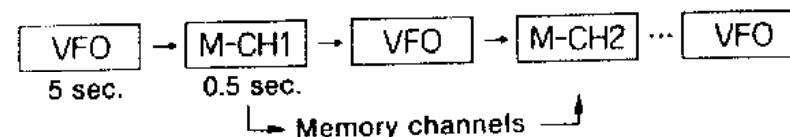

Start priority scan during memory scan.

Memory scan, select memory scan and mode select scan can be used with priority watch.

5-1 SET mode description

The SET mode allows you to modify initial settings for customized operating conditions that suit your individual requirements.

Settings modified in SET mode are mainly for operating conditions, but power-saving operating to conserve battery power can also be set in this mode.

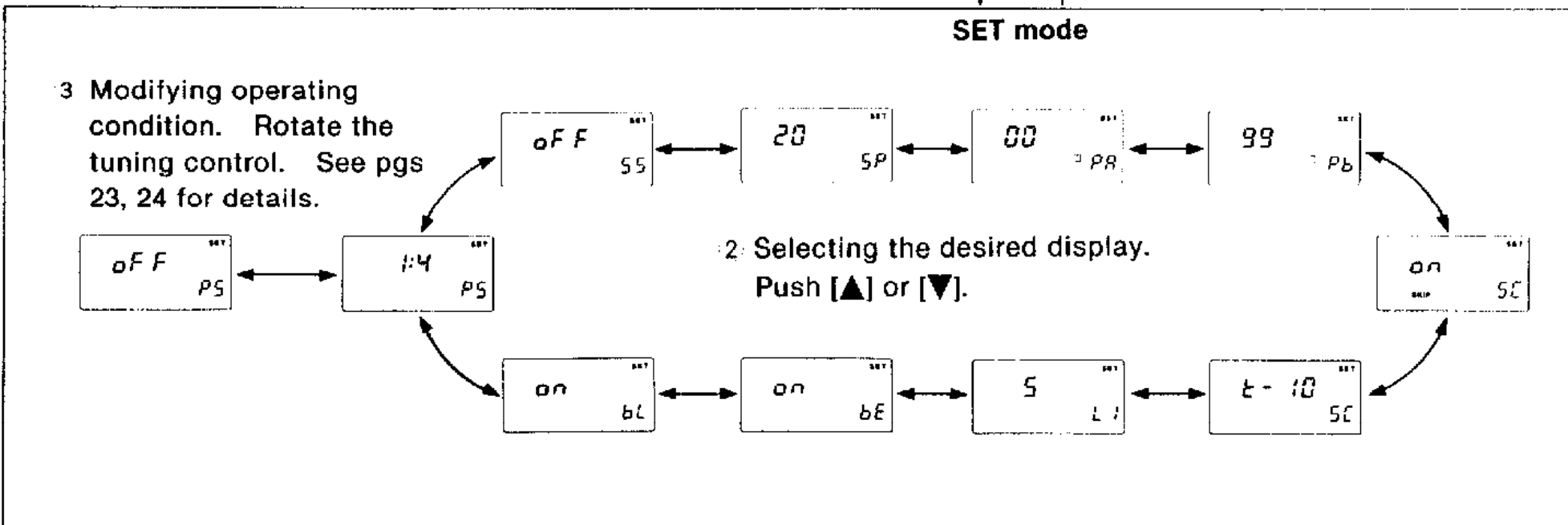
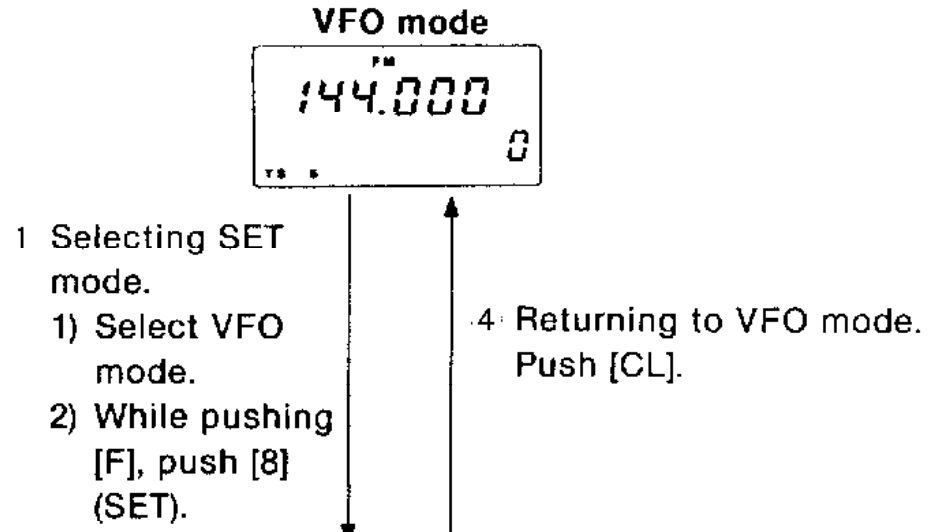

5-2 Setting displays

The displays of the left side are selected when purchasing or after resetting the receiver.

• Scan speed

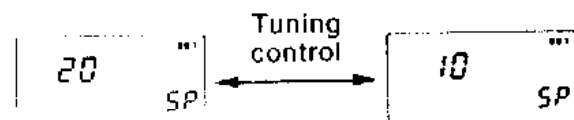

- Changes scan speed. Setting scan speed to 10 slows scanning.
- The setting is valid for all scans except priority watch.

• Memory scan range A

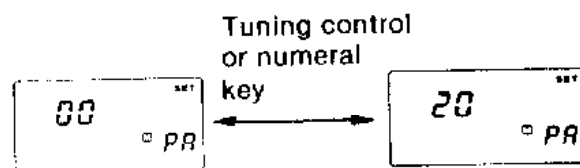

- Limits the range for memory scans (Includes all scans in MEMORY mode). Used in conjunction with memory scan range B (see the next item) to set the upper and lower frequency limits for memory channels.

• Memory scan range B

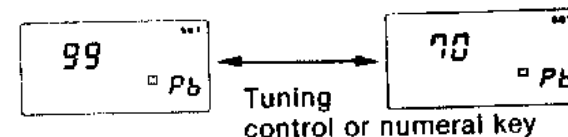

- Used to set the other limit in conjunction with memory scan range A in item above.

• Programmed skip scan function ON/OFF

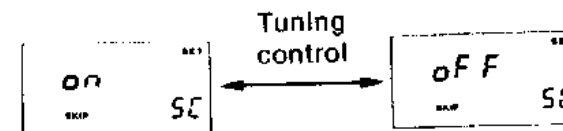

- Turns the programmed skip scan function ON and OFF.
- When set in the "OFF" position, you cannot write in a SKIP command during programmed scan or execute programmed skip scan.

• Scan resume condition from pause

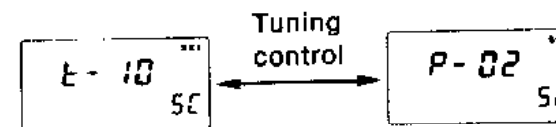

- Scans pause for about 10 sec. on a signal received during scanning, and then resume.
- If you set "P-02," scanning will not resume when a signal received during scanning. Scanning resumes about 2 sec. after the signal disappears.

• **Display lamp control**



- The display lamp normally comes on after pushing [LIGHT] and then goes off automatically after 5 seconds.
- When the lamp control is in the "ON" position, the lamp turns ON and OFF each time you push [LIGHT], and the automatic turn OFF function is deactivated.

• **Beep tone ON/OFF**

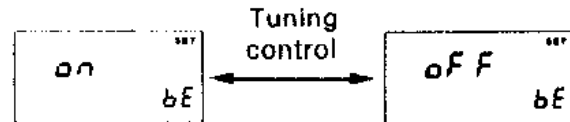

- This function turns ON and OFF the beep tone that the receiver emits each time a switch is pushed.

• **RX (receive) lamp ON/OFF**

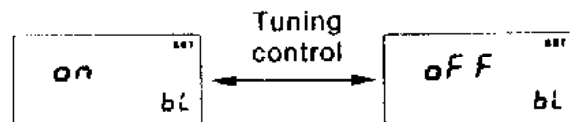

- This function turns the RX lamp light ON and OFF.
- In the "ON" position, the RX lamp lights when a signal is received. In the "OFF" position, the lamp does not light.

• **Setting the power saver time ratio**

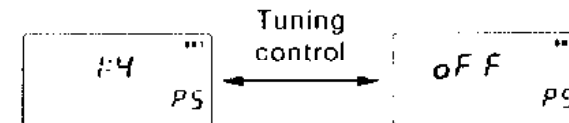

- The larger the ratio set the longer the power saver time.
- The power saver function is deactivated if this function is set to the "OFF" position.
See p. 27 for more information.

• **Power saver scan ON/OFF**

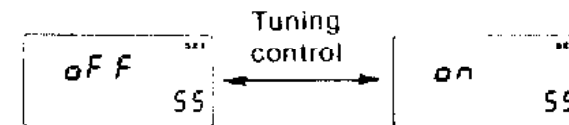

- When set in the "ON" position, this function activates the power saver function if no signal is received during scanning.

6

CLOCK MODE

The CLOCK mode is used to set clock time, the power-on timer and the sleep timer. Time is set using a 24-hour clock.

Time error: ± 1 min/week

• Operating the CLOCK mode

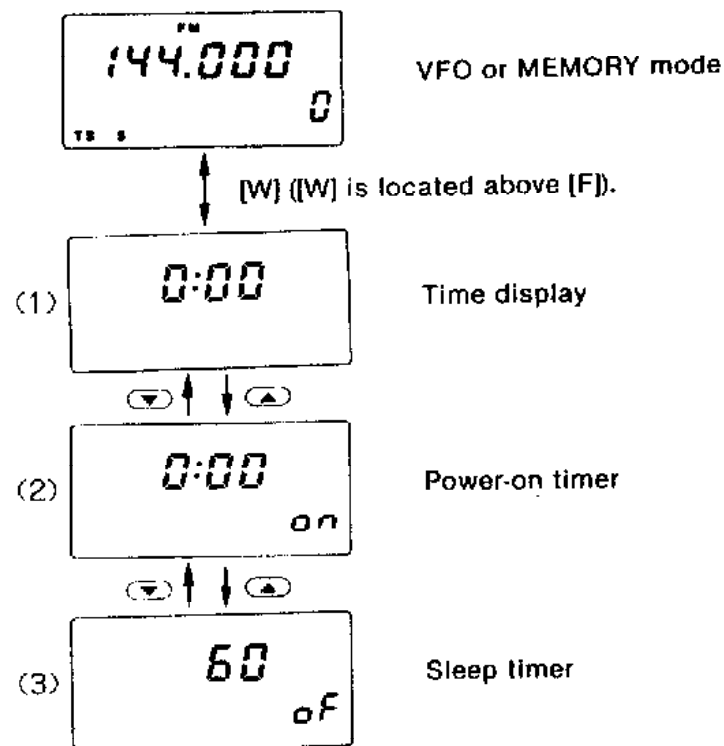

• Setting time

The following explains how to set the current time, which is used for each of the timer functions.

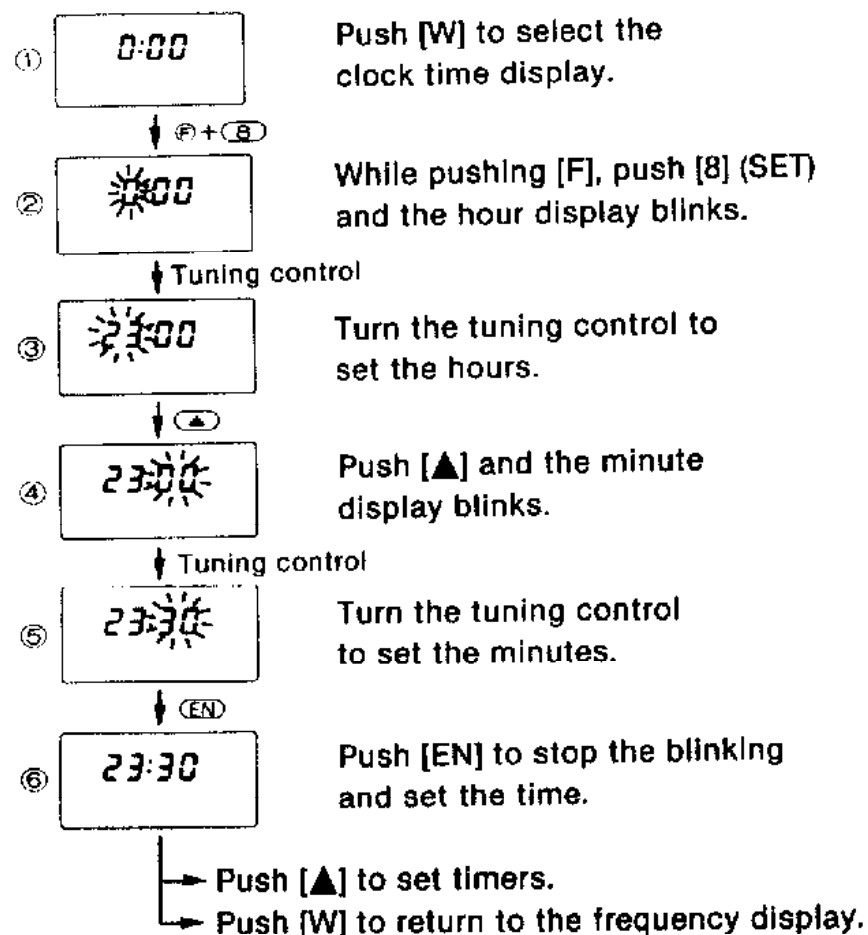

• Power-on timer

While the timer is activated, the receiver is OFF which means that the function display shows the clock time, and the receiver circuit and function keys do not operate.

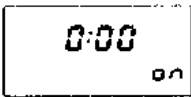
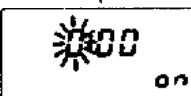
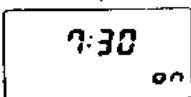
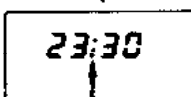
- ①  Select CLOCK mode and push [▲] or [▼] to call up the power-on timer display.
 - ②  While pushing [F], push [8] (SET) and the hour display blinks.
Set the hours and minutes following steps (2~5) in the instructions for "Setting time" on the page at left.
 - ③  Push [EN] to set the power-on time.
 - ④  While pushing [F], push [4] (AP ON) to activate the power-on timer.
• DO NOT turn power OFF with [PWR/VOL].
- A dot appears during timer operation

TO DEACTIVATE THE POWER-ON TIMER

Turn power OFF and ON again using the [PWR/VOL] control.

• Setting the sleep timer

The sleep timer turns power OFF after the pre-selected time is passed. 20, 40 and 60 minutes as the pre-selected time.

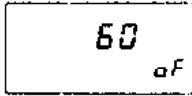
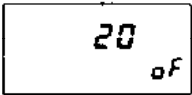
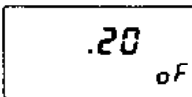
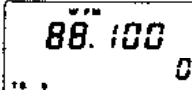
- ①  Select CLOCK mode and push [▲] or [▼] to call up the sleep timer display.
- ②  Rotate the tuning control to set the desired time.
 While pushing [F], push [5] to start the timer.
• A decimal points blink.
- ③  Push [W] to return to normal operations.

USING THE SLEEP TIMER

Once the sleep time is selected, the sleep timer is easy to use in anytime.

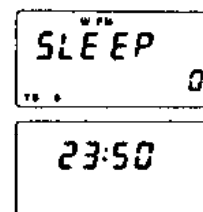

- While pushing [F], push [5] (SLEEP).
- "SLEEP" appears for about 2 seconds.
 - A decimal point appears when selecting the sleep timer display.

7-1 Frequency lock

While pushing [F], push [LIGHT] (LOCK) to deactivate the tuning control and keyboard.

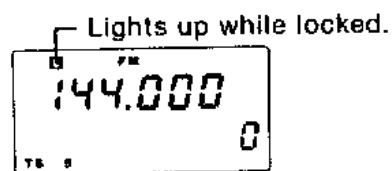

[SQUELCH] and [PWR/VOL] will be operable. This function prevents the frequency from changing inadvertently when you want to listen to the same frequency for a long period of time. To clear the lock function, push [F]+[LIGHT] again.



7-2 Display contrast

While pushing [CONT], turn the tuning control to change the contrast of the function display. Four contrast levels are available.

7-3 Low battery indication

 lights on the function display to indicate a low battery condition while using the built-in NiCd batteries or the optional battery pack. Charge as soon as you see  light.

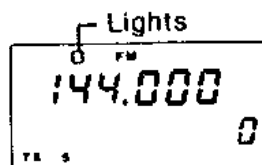

7-4 Power saver

The receiver has a power saver function that conserves battery power by automatically activating after a set period in which no signal is received (standby).

Set the time ratio in the SET mode to activate this function. (See p. 24)

POWER SAVER OPERATING RATIO:

1 : 4	Receiver standby	125 msec.
	Receiver circuit off	500 msec.
1 : 16	Receiver standby	125 msec.
	Receiver circuit off	2 sec.

7-5 Beep tones

Beep tones indicate whether or not an operation has been properly executed.

- Proper execution is indicated by a short beep
- Properly executing [EN] is indicated by a long beep
- Proper execution of memory write is indicated by three short beeps
- Misoperations are indicated by a deep beep tone.

To turn the beep tone OFF, use SET mode (see p. 24). The volume of the beep tone is about the same as that adjusted for received signals.

7-6 Resetting

An abnormal display during operation is usually caused by a CPU error or an external factor such as static electricity.

Should this happen, turn the power OFF once for several seconds, and turn the power back ON. If the display is still abnormal, reset the receiver as follows.

• Resetting

- 1) Turn the power OFF.
- 2) While pushing [F] and [CL], turn the power ON to reset the receiver and return to initial settings.

• Reset conditions

Display after resetting

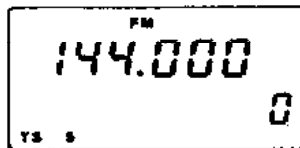

- Memory channel
Channels 0~19: 144.00 MHz
Channels 20~99: Masked
- SET mode
All values return to initial settings.
(See pgs. 23, 24)
- Programmed scan frequency band
Memory A (0A~9A): 144.000MHz FM
Memory B (0B~9B): 146.000MHz FM
- The clock and power-on timer both return to 0 : 00
- Sleep timer returns to 60 min

7-7 Recharging lithium batteries

If the receiver is not used within 1 week after the internal battery is exhausted, the capacity of the lithium backup battery may be exhausted and memory information erased.

Nothing will show on the display when power is turned ON.

- The lithium battery is normally recharged automatically by the built-in NiCd battery, the battery pack or an external power source.

• No display when power is turned ON

- 1) Recharge following the normal procedure. The lithium battery will be fully operational after 1 hour of recharging. (The internal NiCd must be charged for about 15 hours.)
- 2) After charging for about 1 hour, follow the procedure for resetting the receiver and turn the power ON. (While pushing [F]+[CL], turn the power ON.)

The contents of MEMORY and SET mode will all return to initial settings. (Refer to 7-6 Resetting for details.)

8

TROUBLESHOOTING

PROBLEM	POSSIBLE CAUSE	SOLUTION	REF.
<ul style="list-style-type: none"> No display with power turned ON. The contents of memories are erased. 	<ul style="list-style-type: none"> The lithium battery requires charging. 	<ul style="list-style-type: none"> Charge the internal batteries. 	p. 28
<ul style="list-style-type: none"> Weak reception, excessive distortion or too much noise. 	<ul style="list-style-type: none"> Not centered on the frequency. Wrong mode. [SQUELCH] is turned too far clockwise. A self-oscillation is received. Interference. Batteries are exhausted. 	<ul style="list-style-type: none"> Select a small tuning step and set to the central frequency. While pushing [F], push [1] (MODE) to select the correct mode. Rotate [SQUELCH] counterclockwise. Change the frequency. Use supplied antenna or an antenna tuned at the desired frequency. Charge the internal batteries. 	<p>p. 12</p> <p>p. 12</p> <p>p. 9</p> <p>p. 1</p> <p>p. 1</p> <p>p. 27</p>
<ul style="list-style-type: none"> Cannot tune with the tuning control. 	<ul style="list-style-type: none"> Frequency lock is ON. 	<ul style="list-style-type: none"> Turn OFF the function. 	p. 27
<ul style="list-style-type: none"> Cannot call up memory channels. 	<ul style="list-style-type: none"> Improper operating mode. 	<ul style="list-style-type: none"> Select VFO mode and then try again. 	p. 13
<ul style="list-style-type: none"> Cannot start scanning. 	<ul style="list-style-type: none"> [SQUELCH] is turned too far counterclockwise. Required settings not preset. 	<ul style="list-style-type: none"> Rotate [SQUELCH] clockwise. Read again the instructions. 	<p>p. 15</p> <p>p. 15</p>
<ul style="list-style-type: none"> Scanning is slow. 	<ul style="list-style-type: none"> Improper scan speed. Power saver scan is ON. 	<ul style="list-style-type: none"> Select the scan speed in SET mode. Turn OFF the power saver scan. 	<p>p. 23</p> <p>p. 24</p>
<ul style="list-style-type: none"> Cannot enter SET mode. 	<ul style="list-style-type: none"> Not accessed from VFO mode. 	<ul style="list-style-type: none"> Select VFO mode and then try again. 	p. 22
<ul style="list-style-type: none"> Cannot recharge the internal battery. 	<ul style="list-style-type: none"> Recharged without turning OFF the power. An external battery pack is connected. 	<ul style="list-style-type: none"> Charge the internal battery when power is turned OFF. Disconnect the battery pack and then charge again. 	<p>p. 3</p> <p>p. 3</p>

• Frequency coverage:

VERSION	FREQUENCY COVERAGE
U.S.A., Australia, Asia	100 kHz~1300 MHz
Germany	13.95~14.5 MHz, 28~29 MHz, 144~146 MHz, 430~440 MHz, 1240~1300 MHz
France	100 kHz~87.5 MHz, 108~1300 MHz

Specifications guaranteed
2~905 MHz.

- Selectable tuning step : 0.5, 5, 8, 9, 10, 12.5, 15, 20, 25, 30 or 50 kHz
- Number of memory channels : 100
- Mode : FM, AM, Wide FM (WFM)
- Antenna impedance: 50 Ω (unbalanced)
- Power supply requirement : 7.2 V DC (internal battery)
Optional BP-81~BP-85 or BP-90
External DC power 6~16 V DC
- Current drain : Max. audio output Less than 300 mA
Power saved Average 15 mA
Duty cycle Receive: Standby=1 : 16
- Usable temperature range : -10 °C~+60 °C; +14 °F~+140 °F
- Dimensions : 49 (W) \times 102.5 (H) \times 35 (D) mm
1.9 (W) \times 4.0 (H) \times 1.4 (D) in
(projections not included)
- Weight : 280 g; 9.9 oz

- Receive system : AM, FM Triple-conversion superheterodyne
WFM Double-conversion superheterodyne
- Intermediate frequencies : 1st 266.7000~266.7095 MHz
2nd 10.7000 MHz
3rd 455 kHz (FM/AM only)
- Sensitivity : AM (for 10 dB S/N)
1.6 μ V (2~24.9995 MHz)
0.79 μ V (25~905 MHz)
FM (for 12 dB SINAD)
0.79 μ V (2~24.9995 MHz)
0.4 μ V (25~905 MHz)
WFM (for 12 dB SINAD)
6.3 μ V (2~24.9995 MHz)
3.16 μ V (25~905 MHz)
- Squelch sensitivity : AM 1.26 μ V (2~24.9995 MHz)
0.63 μ V (25~905 MHz)
FM 0.63 μ V (2~24.9995 MHz)
0.32 μ V (25~905 MHz)
- Selectivity : AM More than 15 kHz/ -6 dB
FM More than 15 kHz/ -6 dB
WFM More than 150 kHz/ -6 dB
- Audio output power: 150 mW at 10 % distortion with an 8 Ω load
- Audio output impedance : 8 Ω

All stated specifications are subject to change without notice or obligation.

10 OPTIONS

• Battery packs, battery case and carrying cases

Icom offers a wide variety of options to suit your operating needs.

BATTERY PACKS	OUTPUT VOLTAGE	BATTERY CAPACITY	HEIGHT	CARRYING CASES
Internal batteries	7.2 V	300 mAh	—	LC-57
BP-81	7.2 V	110 mAh	30.0 mm; 1.2 in	—
BP-82	7.2 V	300 mAh	40.0 mm; 1.6 in	LC-59
BP-83	7.2 V	600 mAh	59.5 mm; 2.3 in	LC-59
BP-84	7.2 V	1000 mAh	76.0 mm; 3.9 in	LC-61
BP-85	12.0 V	340 mAh	76.0 mm; 3.9 in	LC-61
BP-90*	Battery case for 6 R6 (AA) size batteries.		59.5 mm; 2.3 in	LC-59

*Can be charged when NiCd batteries are installed.

• Battery chargers

BC-72 DESKTOP CHARGER

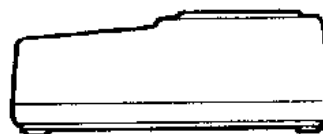

Rapidly charges the BP-81~BP-85 and IC-R1 internal batteries. Both AC and DC can be used as a power supply.

BC-73E/D WALL CHARGER



Fully charges the BP-81 and BP-82 and IC-R1 internal batteries. Available in Asia and Europe only. Same type as supplied with Europe, France and Asia versions.

BC-74A/E/D/V WALL CHARGER



Fully charges the BP-81~BP-85 and IC-R1 internal batteries. Same type as supplied with the U.S.A. and Australia versions.

• Charging cables

CP-12 CIGARETTE LIGHTER CABLE WITH NOISE FILTER

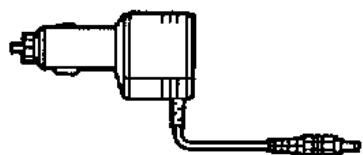

Allows you to use the IC-R1 through a 12 V cigarette lighter socket. Also charges the BP-81~BP-85 and IC-R1 internal batteries.

OPC-254 MINI DC POWER CABLE



For use with a 13.8 V DC power supply. Equipped with fuses. Also charges the BP-81~BP-85 and IC-R1 internal batteries.

• Other options

AD-14 BATTERY CHARGE ADAPTER

Allows to charge the BP-81~BP-84 and BP-90 with NiCd batteries separated from the IC-R1. Use together with the supplied wall charger or an optional CP-12 or OPC-254.

BA-11 BOTTOM CAP

Protective cap for terminals on the base of the IC-R1 when using an external DC power supply.

BA-12 BATTERY CHARGE ADAPTER

Allows you to rapidly charge the IC-R1 internal batteries with the BC-72.

FA-4B VHF/UHF WIDEBAND FLEXIBLE ANTENNA

Same type supplied with the IC-R1.

ME-35 EARPHONE

Provides clear audio in noisy environments.

MB-30 MOUNTING BRACKET

Mounts the IC-R1 in a vehicle or on a wall.

HP-4 COMMUNICATION HEADPHONES

Monaural headphones for clear audio in noisy environments.

Count on us!

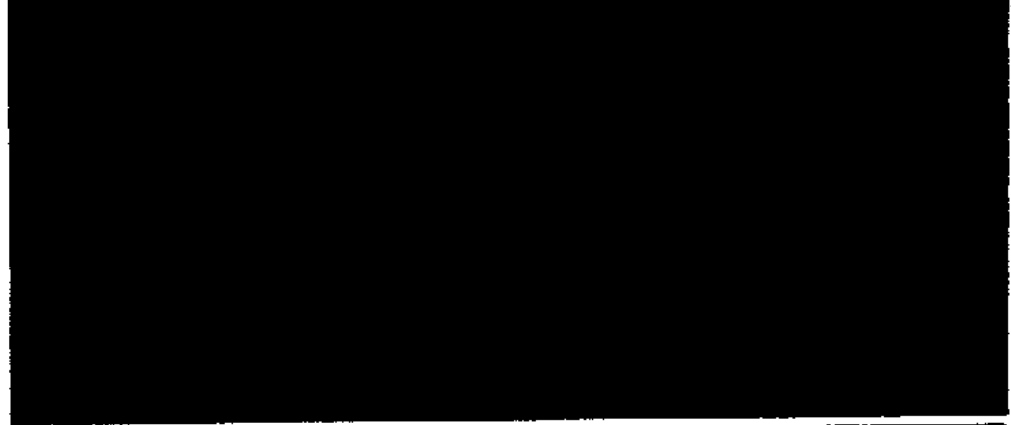

A-5104H-1EX
Printed in Japan
Copyright © 1990 by Icom Inc.

Icom Inc.
6-9-16, Kamihigashi, Hirano-ku, Osaka 547, Japan

■ FREQUENCY TUNING

- USING THE TUNING CONTROL 1**
 ① Select VFO. ② The frequency changes in tuning step (TS).
- USING THE TUNING CONTROL 2**
 ① Select VFO. ② + The frequency changes in the dial select step.
- SELECTING THE TUNING STEP**
 ① Select VFO. ② + Keep holding ③ +
- SELECTING THE DIAL SELECT STEP**
 ① Select VFO. ② +

- USING THE KEYBOARD**
 ① Select VFO. ② MHz digits ③ ④ kHz digits ⑤
- SELECTING THE RECEIVE MODE**
 + Each push changes the receive mode.
- FREQUENCY LOCK**
 + Each push switches the frequency lock and unlock.
- CONTRAST SET**
 + Contrast changes in 4 levels.

A-5104H-2EX Printed in Japan
Copyright © 1990 by Icom Inc.

■ MEMORY CHANNEL SELECTING

- USING THE TUNING CONTROL 1**
 ① Select MEMORY. ② Programmed channels can only be selected.
- USING THE TUNING CONTROL 2**
 ① Select MEMORY. ② + All memory channels can be selected.
- USING THE KEYBOARD**
 ① Select MEMORY. ② 1 or 2 digits ③
- USING UP/DOWN KEY**
 or Memory channel number can be selected even in VFO mode.

- MEMORY WRITE**
 ① Select the memory channel (See at left). ② Select VFO mode. ③ Set the frequency and mode. ④ + Push and hold.
- MEMORY CONTENTS TRANSFERRING**
 ① ② Select the memory channel (See at left). ③ + Push and hold.
- MEMORY MASK (CONTENTS CLEAR)**
 ① ② Select the memory channel (See at left). ③ +

■ SCAN

• PROGRAMMED SCAN

- ① ② + ③ ~ Push a group number.

• AUTO WRITE MEMORY SCAN

- ① ② + ③ ~ Push a group number.

• MEMORY SCAN

- ① ② + Select MEMORY

• SELECT MEMORY SCAN

- ① ② + Select MEMORY

• MODE SELECT SCAN

- ① ② + ③ + Select MEMORY Select a mode.

• SCAN EDGE PROGRAMMING

- ① ② + ③ or Select VFO Select an edge channel.
④ ⑤ or ⑥ ⑦ Set frequency. Set the other side of edge channel. Set frequency.

• MEMORY SKIP PROGRAMMING

- ① ② Select the memory channel. ③ + Select MEMORY

■ PRIORITY WATCH

- Select the watching channel. or Start a memory scan.
① (A memory channel) (Memory scan
Select memory scan
Mode select scan)
② +

■ SET MODE

• SET MODE ACCESSING

- ① ② + ③ or Select VFO Access SET mode. Select a display.
④ ⑤ Set contents Exit SET mode.

DISPLAY	SETTING CONTENTS
SP	Scan speed
PA	Memory scan edge
Pb	
SC SKIP	Programmed skip scan ON/OFF
SC	Scan resume condition
LI	Light timer
bE	Beep tone ON/OFF
bL	RX lamp (busy lamp)
PS	Power saver duty ratio
SS	Power saver scan ON/OFF

■ CLOCK MODE

• CLOCK SET

- ① ② + ③ Clock display Set hours.
④ ⑤ ⑥ Set minutes. Exit CLOCK mode.

• POWER ON TIMER

- ① ② ③ + Clock display Indicate "on."
④ ⑤ ⑥ ⑦ Set hours. Set minutes.
⑧ + or Start the timer. Exit CLOCK mode.

• SLEEP TIMER

- ① ② × 2 times ③ Clock display Indicate "of."
④ + or Start the timer. Exit CLOCK mode.

■ SCAN

• PROGRAMMED SCAN

- ① Select VFO
- ② + Push a group number.
- ③ Push a group number.

• AUTO WRITE MEMORY SCAN

- ① Select VFO
- ② + Push a group number.
- ③ Push a group number.

• MEMORY SCAN

- ① Select MEMORY
- ② +

• SELECT MEMORY SCAN

- ① Select MEMORY
- ② +

• MODE SELECT SCAN

- ① Select MEMORY
- ② + Select a mode.
- ③ +

• SCAN EDGE PROGRAMMING

- ① Select VFO
- ② + Select an edge channel.
- ③ or Select an edge channel.
- ④ Set frequency.
- ⑤ or Set the other side of edge channel.
- ⑥ or Set frequency.
- ⑦

• MEMORY SKIP PROGRAMMING

- ① Select MEMORY
- ② Select the memory channel.
- ③ +

■ PRIORITY WATCH

- ① Select the watching channel. or (Memory scan (A memory channel) Mode select scan)
- ② + Start a memory scan.

■ SET MODE

• SET MODE ACCESSING

- ① Select VFO
- ② + Access SET mode.
- ③ or Select a display.
- ④ Set contents
- ⑤ Exit SET mode.

DISPLAY	SETTING CONTENTS
SP	Scan speed
	Memory scan edge
SC SKIP	Programmed skip scan ON/OFF
SC	Scan resume condition
LI	Light timer
bE	Beep tone ON/OFF
bL	RX lamp (busy lamp)
PS	Power saver duty ratio
SS	Power saver scan ON/OFF

■ CLOCK MODE

• CLOCK SET

- ① Clock display
- ② + Set hours.
- ③ Set minutes.
- ④ Set minutes.
- ⑤ Exit CLOCK mode.

• POWER ON TIMER

- ① Clock display
- ② Indicate "on."
- ③ + Set hours.
- ④ Set hours.
- ⑤ Set minutes.
- ⑥ Set minutes.
- ⑦ Start the timer.
- ⑧ + or Exit CLOCK mode.

• SLEEP TIMER

- ① Clock display
- ② x 2 times Indicate "of."
- ③ Start the timer.
- ④ + or Exit CLOCK mode.